

Model Number
RMCS-3081

INDUSTRIAL GRADE IG50 PLANETARY DC GEARED MOTOR 60W 520RPM 24V 8KGCM

Mechanical Drawing (Dimensions are in mm)

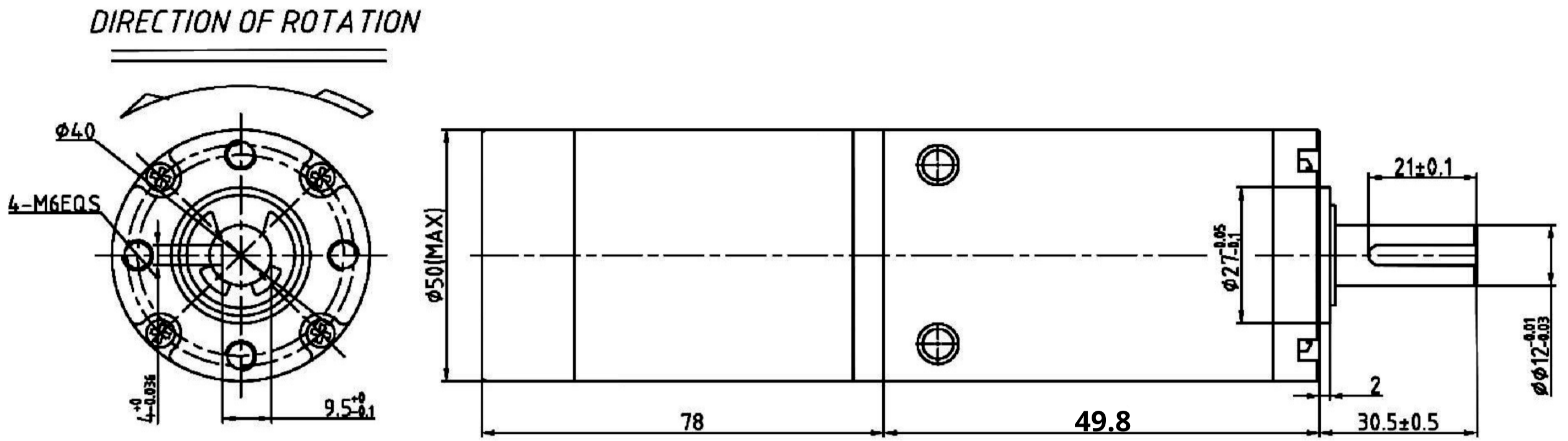

Technical Specifications of Motor

Motor Type	HEAVY DUTY PLANETARY GEARED MOTOR
Operating Voltage	24 V DC
Motor Speed at Output Shaft (RPM)	520 RPM
Stall Torque (Kgcm)	12 Kgcm
Rated Torque (Kgcm)	8 Kgcm
Gear Ratio	1:13.7
Weight	1180g
Gearbox Breaking Torque (Kgcm)	200 Kgcm

Base Motor Specifications

Nominal Voltage (V)	24 V DC
No load Speed (RPM)	7000 RPM
Rated Torque	66.80mN.m
No-load current (A)	0.75 A

